

4200 Series
Commercial Exit Device

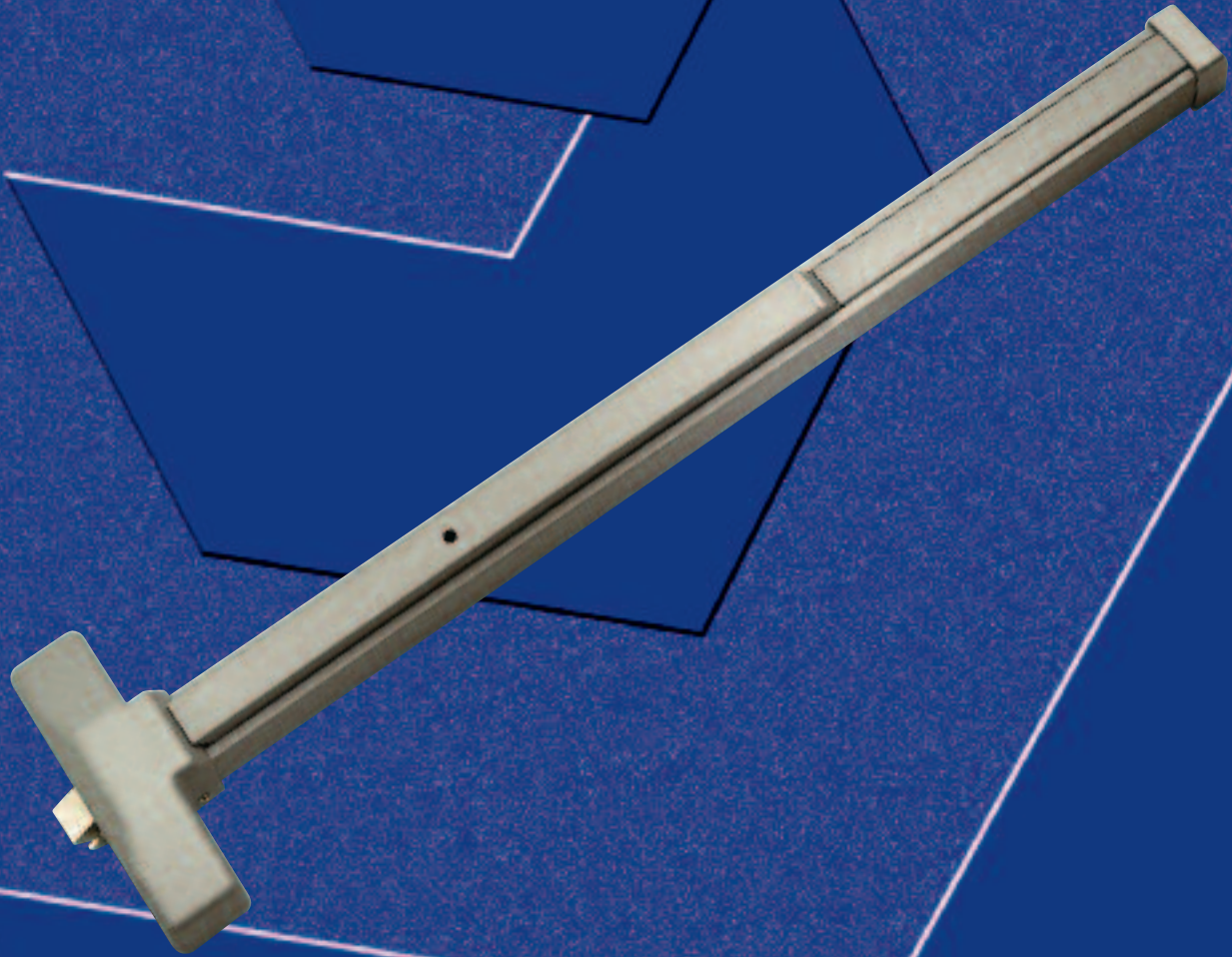

4200 SERIES

Commercial Exit Device

SUGGESTED ARCHITECTURAL SPECIFICATIONS

All exit devices shall be American Eagle 4200 Series rim or surface vertical rod devices. Surface vertical rod devices to have top and bottom pullman latch bolts. Latch bolts to be dead locking where applicable. All touch bar components to be constructed of heavy gauge wrought steel or stainless steel. Devices to be furnished with metal chassis covers and end caps. Devices to be available for non-labeled doors and fire labeled doors. Devices for non-labeled doors shall have

hex key dogging standard. All devices to offer a variety of trim options including pulls, standard rose trim, heavy duty rose trim, escutcheon and thumb piece trim. Fasteners to be furnished for wood and metal applications. Fire labeled devices furnished standard with sex nuts. Devices shall be listed by U.L./U.L.C. and comply with U.L. 10C and UBC 7-2 (1997) for positive pressure. All products to carry a 5-year limited warranty.

SPECIFICATIONS – 4200 SERIES

CHASSIS:	Cadmium plated steel
RAIL:	Heavy gauge steel or stainless steel
TOUCH PAD:	Heavy gauge steel or stainless steel
LATCH BOLT:	Stainless steel dead locking / 3/4" throw Rim / 5/8" throw SVR
PROJECTION:	2-5/8" projection
HAND:	Device is non-handed
DOGGING:	Hex key dogging standard / Cylinder dogging optional / No dogging on fire labeled devices
APPLICATION:	Rim or surface vertical rod (7'0" tall door standard)
BACKSET:	Covers 161 prep for rose trim
STILE WIDTH:	4-1/4" minimum
DOOR THICKNESS:	1-3/4"
DOOR WIDTH:	"A" size for 3'0" - 4'0" door maximum
DEVICE FINISHES:	Aluminum, duro, gold, satin chrome, polished brass and satin stainless steel
FASTENERS:	Fasteners furnished for wood and metal door applications / Sex nuts and bolts standard with fire labeled devices
CERTIFICATION:	<ul style="list-style-type: none"> ▶ U.L./U.L.C. listed for "Panic", "Fire Exit Hardware" labeled for up to 1-1/2 hour for 3'0" x 7'0" maximum single, 6'0" x 7'0" maximum pairs ▶ Complies with U.L. 10C and UBC 7.2 (1997)
WARRANTY:	Five (5) year limited warranty

4200 SERIES

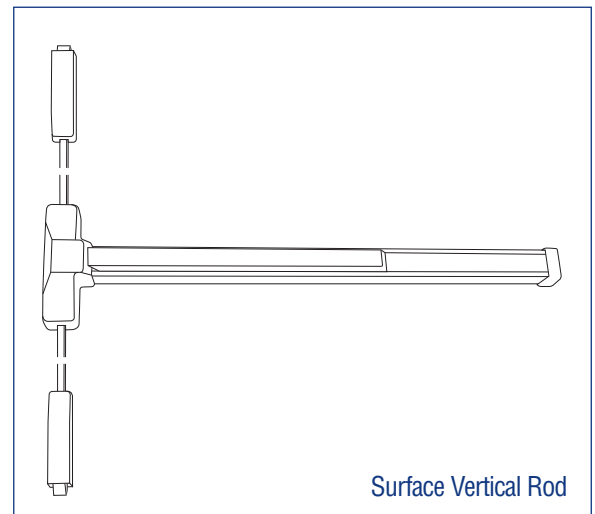
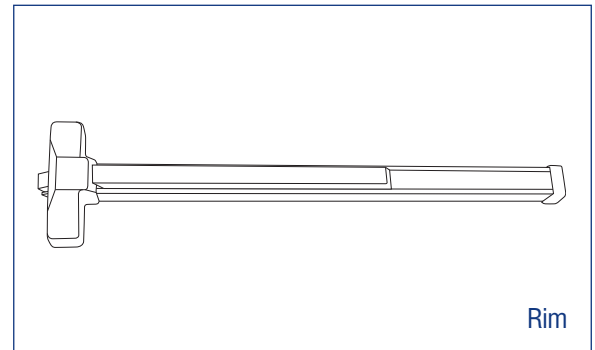

TRIM SELECTION

ANSI FUNCTION	DESCRIPTION	PULL PLATE/BLANK ESCUTCHEON	NARROW ESCUTCHEON TRIM*	HEAVY DUTY WIDE ESCUTCHEON TRIM	KEY-IN-KNOB/LEVER ROSE TRIM	HEAVY DUTY KEY-IN-LEVER ROSE TRIM	GRIP PULL/THUMB PIECE**
01	Exit only, no trim or blank escutcheon.	429 PTD	—	—	—	—	—
02	Entrance by trim when actuating bar is locked down (dummy trim).	429 PUN	429 LPENX	429 LPENXH	—	—	429 GPH
03	Entrance by trim when latch bolt is retracted by key. Key removable only when locked (night latch).	429 PUK	—	—	429 LPS	429 LPSH/ 429 LPSH-IC	429 GPG***
05	Entrance by thumb piece. Key locks or unlocks thumb piece (classroom thumb piece).	—	—	—	—	—	429 GPK
08	Entrance by knob or lever. Key unlocks knob or lever (classroom knob/lever).	—	429 LPEKF	429 LPEKFH	429 LPK/ 429 CQK	429 LPKH/ 429 LPKH-IC	—
09	Entrance by knob or lever only when released by key. Key removable only when locked (storeroom knob/lever).	—	429 LPEKX	429 LPEKXH	—	—	—
14	Entrance by trim when latch bolt is released by knob or lever. Always active, no cylinder (passage knob/lever).	—	429 LPENF	429 LPENFH	429 LPN/ 429 CQN	429 LPNH	—
15	Entrance by trim when latch bolt is released by thumb piece. Always active, no cylinder (passage thumb piece).	—	—	—	—	—	429 GPN

Note: *429 LPE trim furnished with 1-1/4" mortise cylinder (1-1/8" cylinder will also work)

**429 Series Grip Pull furnished with 1-1/4" mortise cylinder (1-1/8" cylinder will also work, except GPG)

***429 GPG furnished with 1-1/4" mortise cylinder with rim tail piece

4200 SERIES DOOR WIDTH CHART

		FOR DOOR	MIN DOOR	MAX CUT	PUSH PAD
4200R-0X	4200 Rim Regular dogging	36"	27"	9"	18"
4200RF-0X	4200 Rim Fire	36"	27"	9"	18"
4200V-0X	4200 SVR Regular dogging	36"	27"	9"	18"
4200VF-0X	4200 SVR Fire	36"	27"	9"	18"
4200RA-0X	4200 Rim Regular dogging	48"	39"	9"	30"
4200RFA-0X	4200 Rim Fire	48"	39"	9"	30"
4200VA-0X	4200 SVR Regular dogging	48"	39"	9"	30"
4200VFA-0X	4200 SVR Fire	48"	39"	9"	30"

ACCESSORIES/OPTIONS

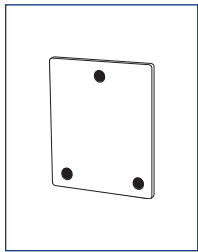

429 PTD

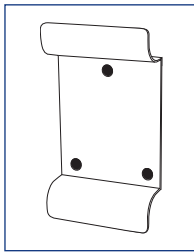

429 PUN

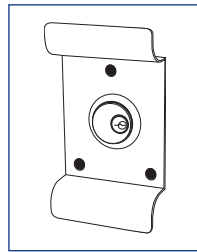

429 PUK

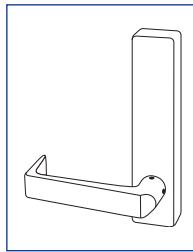

429 LPENX/429 LPENF

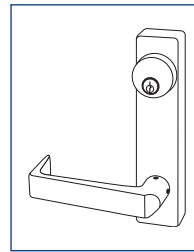

429 LPEKF/429 LPEKX

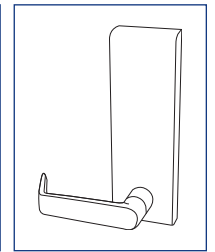

429 LPENXH/429 LPENFH

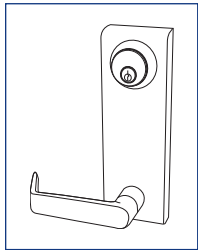

429 LPEKFH/429 LPEKXH

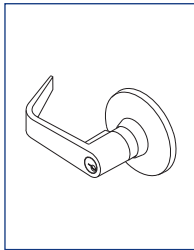

429 LPS/429 LPK

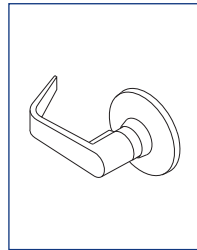

429 LPN

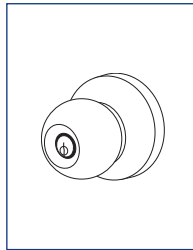

429 CQK

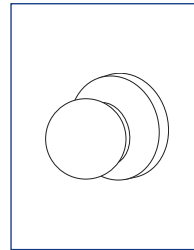

429 CQN

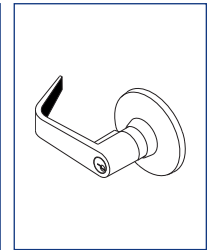

429 LPSH/429 LPKH

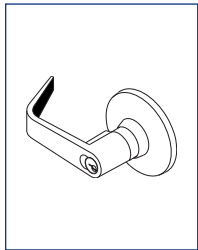

429 LPSH-IC/429 LPKH-IC

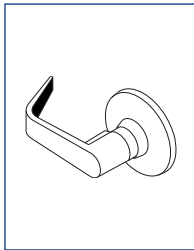

429 LPNH

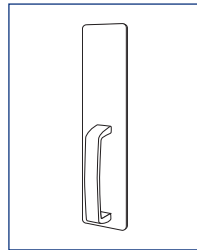

429 GPH

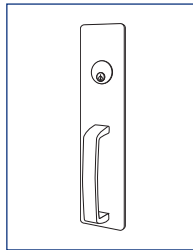

429 GPG

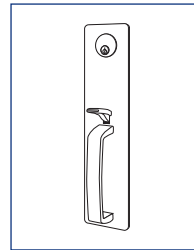

429 GPK

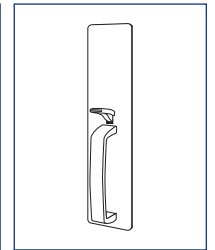

429 GPN

HOW TO ORDER

SERIES		APPLICATION		SIZE		TRIM	
Exit Device Series		R – Rim V – Surface Vertical Rod		A – 3'0" to 4'0" Door		Specify As Required (Example Shown)	
42	00*	R	F	A	630	429LPKH	
00 – Hex Key Dogging (Standard) * Dogging Not Furnished With Fire Labeled Devices		F – Fire Labeled No Designation – Egress (Panic) Labeled		689 – Aluminum 695 – Duro Bronze 696 – Gold 605 – Polished Brass 626 – Satin Chrome 630 – Satin Stainless Steel			
DOGGING		LABELING		FINISH			

ACCESSORIES/OPTIONS

PART	DESCRIPTION
429020	Top surface vertical rod for 7'0" door (furnished with SVR device)
429021	Top surface vertical rod, 1' extension for 8'0" door (optional)
429023	Top surface vertical rod, 3' extension for up to 10'0" door (optional)
429024	Bottom surface vertical rod (furnished with SVR device)
429001	Sex nut and bolt set (furnished standard with fire labeled device)
429002	Lock front filler (furnished with device)
429003	Strike filler (furnished with device)
429004	Rim strike w/1 ea. 1/8" shim (furnished with rim device)
429005	Top strike w/2 ea. 1/16" shims for surface vertical rod (furnished with SVR device)
429006	Bottom strike w/2 ea. 1/16" shims for surface vertical rod (furnished with SVR device)
429014	Trim back plate 2-1/2" x 8" (optional to cover 161 preparation with escutcheon trim)
429017	Trim back plate 3-1/2" x 8" (optional to cover 161 preparation with escutcheon trim)
429018	Adapter plate (furnished with standard duty rose trim)
429015	Shim, end cap, glass lite shim 1/4" (optional, must be used in conjunction with #429016)
429016	Shim, chassis, glass lite shim 1/4" (optional, must be used in conjunction with #429015)
429019	Double door strike (optional)

CROSS REFERENCE

ANSI TYPE	AMERICAN EAGLE	CAL ROYAL	CORBIN/RUSSWIN	DORMA	HAGER	MONARCH	YALE	SARGENT	S PARKER	PRECISION	TELL	VON DUPRIN
TYPE 1	4200 R	2200	ED8200	8300	4700 Rim	19 R	2100	2828	UL520	5100	8300	22
TYPE 2	4200 V	2260	ED8400	8400	4700 SVR	19 V	2110	2727	520V	5200	8400	2227

No products are exactly alike. This cross reference represents our judgement of products that are most similar. Information has been obtained from trade sources. It is not represented nor guaranteed that any product exactly equals any other product.



PO Box 507 2754 Creek Hill Road Leola PA 17540
800 441 9692 • 717 656 4281 • 717 656 6892 Fax
www.pdqlocks.com

PDQ'S 4200 Series Brochures are now printed entirely on Forest Stewardship Council certified paper. FSC Certification ensures that the paper used in this catalog contains fiber from well-managed and responsibly harvested forests that meet strict environmental and socioeconomic standards. We're proud to be one of the first hardware manufacturers in the country to make this significant move to help our environment. The FSC logo on our brochure signals not only FSC Certification, but also PDQ's commitment to improving the environment.

