

5300 Slim Cover 5500 Full Cover Series

Commercial Closer Grade 1

Architectural Submittal Sheet

Typical Applications

- Assisted Living
- Exterior Doors in Heavy Draft/Wind Conditions
- Government Facilities
- Healthcare
- Higher Education
- Hospitality
- Houses of Worship
- Industrial
- K-12 Education
- Offices
- Retail

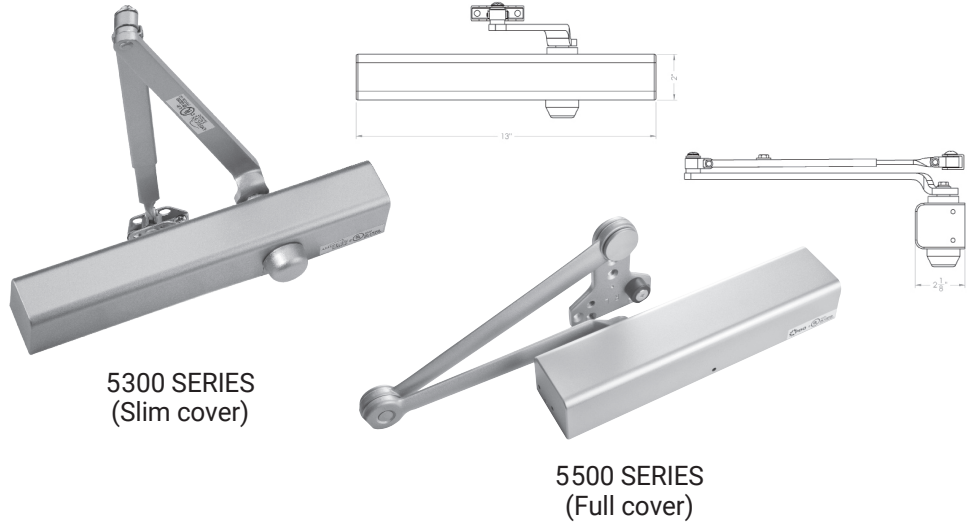

5300 SERIES
(Slim cover)

5500 SERIES
(Full cover)

Specifications



BODY:	• Cast High Strength Aluminum Alloy Body
ARM OPTIONS:	<ul style="list-style-type: none"> • PA – Parallel Arm • HO – Hold Open • DS/DSHO – Heavy Duty Parallel Arm Stop • SCS/SCSHO – Heavy Duty Parallel Arm Cushion Stop • TA/TAHO – Track Arm • EDA/EDAHO – Extra Duty Parallel Arm • PS – Pivot Stop Arm
ADJUSTMENT:	<ul style="list-style-type: none"> • Hydraulic controlled closing • Separate hydraulic backcheck standard • Optional adjustable delayed action (in addition to backcheck)
RETROFIT:	• Common 12" x 3/4" mounting hole pattern retrofits Norton 8300/8500 [®] and Accentra (Yale) 3300/3500
SIZE:	• Adjustable BF through 6 BARRIER FREE
MOUNTING:	<ul style="list-style-type: none"> • Includes sex nuts/bolts and screws for wood/metal doors/frames • Tri-packed for regular, top jamb and parallel arm installations • Separate limiting stop may be required for high abuse applications • Self drilling, self tapping screws standard
COVER:	• 5300 Series - Streamline plastic cover (non-handed) 5500 Series - Full plastic cover standard (field reversible)
FINISHES:	• 605 – Polished Brass, 625 – Polished Chrome, 689 – Aluminum, 693 – Black, 695 – Duro Bronze, 696 – Gold
WARRANTY:	• Twenty-five (25) year Limited Warranty
CERTIFICATIONS, LISTINGS, COMPLIANCES:	<ul style="list-style-type: none"> • UL listed for labeled swinging fire doors rated up to and including 3 hours • Certified to ANSI/BHMA A156.4 Grade 1 • Complies with ADA (Americans with Disabilities Act) and ICC/ANSI 117.1 for Accessible and Usable Buildings • TAA compliant. Country of origin: KR

5300/5500 Series

5300 Series

CODE	DESCRIPTION
5301 BC PA	Closer, BF-6, streamline cover, SNB (Tri-pack)
5301 BC PA HO	Closer, BF-6, hold open, streamline cover, SNB (Tri-pack)
5301 BC DS	Closer, BF-6, door saver, streamline cover, SNB (PA only)
5301 BC DSHO	Closer, BF-6, door saver hold open, streamline cover, SNB (PA only)
5301 BC EDA	Closer, BF-6, extra duty arm, streamline cover, SNB (PA only)
5301 BC EDAHO	Closer, BF-6, extra duty hold open, streamline cover, SNB (PA only)
5301 BC SCS	Closer, BF-6, door saver w/spring cushion stop, streamline cover, SNB (PA only)
5301 BC SCSHO	Closer, BF-6, door saver hold open w/spring cushion stop, streamline cover, SNB (PA only)
5301 BC TA	Closer, BF-6, track arm, streamline cover, SNB (for body only)
5301 BC TAHO	Closer, BF-6, track arm hold open, streamline cover, SNB (for body only)
5301 BC PS	Closer, BF-6, pivot stop, streamline cover, SNB (PA only)

5500 Series

CODE	DESCRIPTION
5501 BC PA	Closer, BF-6, full cover, SNB (Tri-pack)
5501 BC PA HO	Closer, BF-6, hold open, full cover, SNB (Tri-pack)
5501 BC DS	Closer, BF-6, door saver, full cover, SNB (PA only)
5501 BC DSHO	Closer, BF-6, door saver hold open, full cover, SNB (PA only)
5501 BC EDA	Closer, BF-6, extra duty arm, full cover, SNB (PA only)
5501 BC EDAHO	Closer, BF-6, extra duty arm hold open, full cover, SNB (PA only)
5501 BC SCS	Closer, BF-6, door saver w/spring cushion stop, full cover, SNB (PA only)
5501 BC SCSHO	Closer, BF-6, door saver hold open w/spring cushion stop, full cover, SNB (PA only)
5501 BC TA	Closer, BF-6, track arm, streamline cover, SNB (for body only)
5501 BC TAHO	Closer, BF-6, rack arm hold open, streamline cover, SNB (for body only)
5501 BC PS	Closer, BF-6, pivot stop, full cover, SNB (PA only)

Finishes



Options

CODE	DESCRIPTION
SCS-1	For 3'0" X 8'0" wood or hollow metal doors and frames
SCS-2	For 4'0" X 8'0" wood or hollow metal doors and frames

5300/5500 Series

Arms

CODE	DESCRIPTION
RA	REGULAR ARM - Can be mounted REG/TJ/PA (requires PA bracket)
EDA	EXTRA DUTY ARM - PA application only (bumper eliminated)
DS	DOOR SAVER ARM (Limiting Stop) - PA application only
DSHO	DOOR SAVER HOLD OPEN ARM (limiting stop) PA application only
EDAHO	EXTRA DUTY ARM HOLD OPEN - PA application only (bumper eliminated)
HO	HOLD OPEN ARM - can be mounted REG/TJ/PA (requires PA bracket)
TA	TRACK ARM ASSEMBLY - (Includes track, arm and screws)
TAHO	TRACK ARM HOLD OPEN
PA	PARALLEL ARM BRACKET - NON HOLD OPEN applications
PAHO	PARALLEL ARM BRACKET- HOLD OPEN applications
PS	PIVOT STOP ARM - Regular and Top Jamb Only

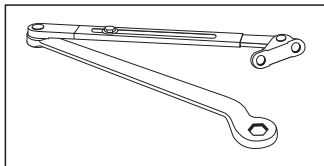

RA - REGULAR ARM

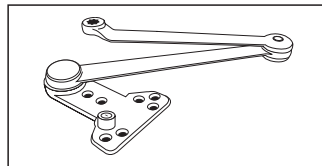

DS - DOOR SAVER (LIMITING STOP) ARM

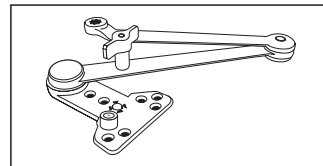

DSHO - DOOR SAVER (LIMITING STOP) HOLD OPEN ARM

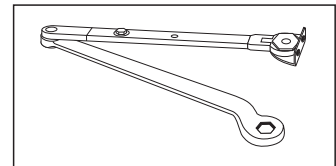

HO - HOLD OPEN ARM

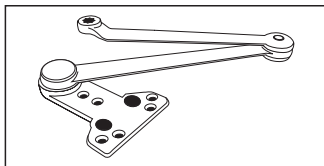

EDA - EXTRA DUTY ARM

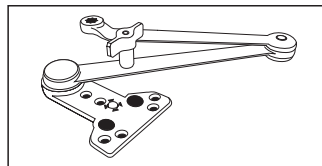

EDAHO - EXTRA DUTY ARM HOLD OPEN

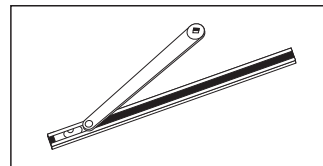

TA - TRACK ARM ASSEMBLY

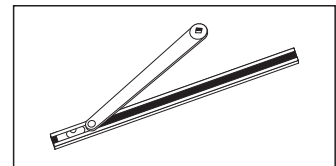

TAHO - TRACK ARM HOLD OPEN

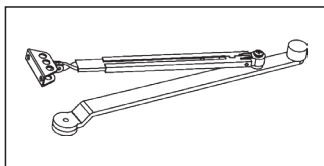

PS - PIVOT STOP ARM

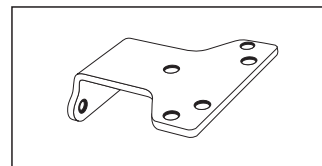

PA - PARALLEL ARM BRACKET

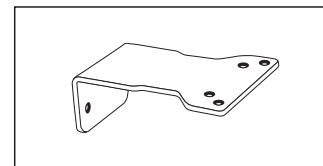

PAHO - PARALLEL ARM HO BRACKET

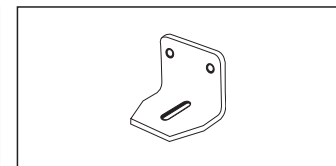

NFB - NARROW FRAME BRACKET