

5300 Slim Cover 5500 Full Cover SERIES

Grade 1 Commercial Closer



Architectural Submittal Sheet

Typical Applications

- Assisted Living
- Exterior Doors in Heavy Draft/Wind Conditions
- Government Facilities
- Healthcare
- Higher Education
- Hospitality
- Houses of Worship
- Industrial
- K-12 Education
- Offices
- Retail

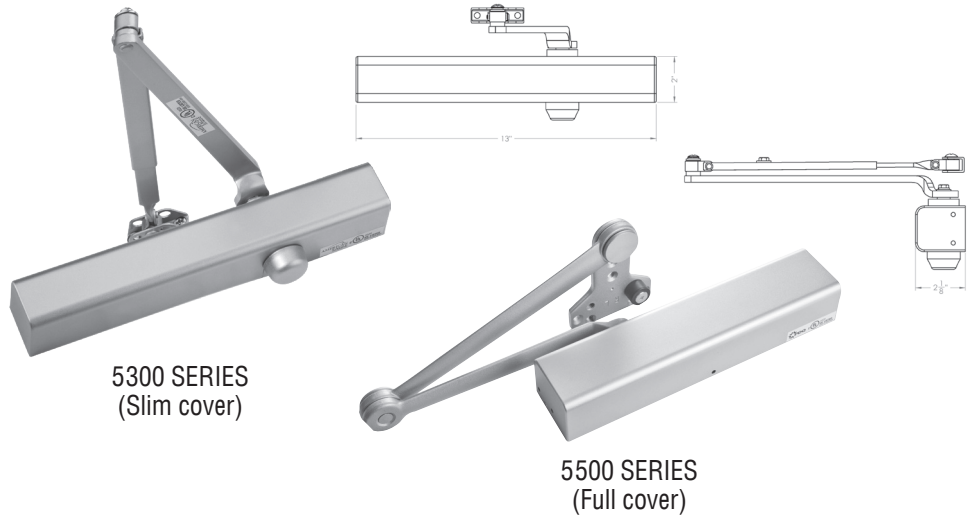

5300 SERIES
(Slim cover)

5500 SERIES
(Full cover)

Specifications



BODY:	• Cast High Strength Aluminum Alloy Body
ARM OPTIONS:	<ul style="list-style-type: none"> • PA – Parallel Arm • HO – Hold Open • DS/DSHO – Heavy Duty Parallel Arm Stop • RA – Regular Arm • SCS/SCSHO – Heavy Duty Parallel Arm Cushion Stop • TA/TAHO – Track Arm • EDA/EDAHO – Extra Duty Parallel Arm • PS – Pivot Stop Arm*
ADJUSTMENT:	<ul style="list-style-type: none"> • Hydraulic controlled closing • Separate hydraulic backcheck standard • Optional adjustable delayed action (in addition to backcheck)
RETROFIT:	• Common 12" x 3/4" mounting hole pattern retrofits Norton 8300/8500® and Yale 3300/3500
SIZE:	• Adjustable BF through 6
MOUNTING:	<ul style="list-style-type: none"> • Includes sex nuts/bolts and screws for wood/metal doors/frames • Tri-packed for regular, top jamb and parallel arm installations • Separate limiting stop may be required for high abuse applications
COVER:	• 5300 Series - Streamline plastic cover (non-handed) 5500 Series - Full plastic cover standard (field reversible)
COLOR & ARCHITECTURAL FINISHES:	• 605 – Polished Brass, 625 – Polished Chrome, 689 – Aluminum, 693 – Black, 695 – Duro Bronze, 696 – Gold
WARRANTY:	• Twenty-five (25) year Limited Warranty
CERTIFICATIONS, LISTINGS, COMPLIANCES:	<ul style="list-style-type: none"> • UL listed for labeled swinging fire doors rated up to and including 3 hours • Certified to ANSI/BHMA A156.4 Grade 1 • Complies with ADA (Americans with Disabilities Act) and ICC/ANSI 117.1 for Accessible and Usable Buildings • Meets requirements of the Buy American Act

5300/5500 SERIES Grade 1 Commercial Closer

Closers







5300 Series

CODE	DESCRIPTION
5301 BC PA	Closer, BF-6, streamline cover, SNB (Tri-pack)
5301 BC RA	Closer, BF-6, regular arm, streamline cover, SNB
5301 BC PA HO	Closer, BF-6, hold open, streamline cover, SNB (Tri-pack)
5301 BC DS	Closer, BF-6, door saver, streamline cover, SNB (PA only)
5301 BC DSHO	Closer, BF-6, door saver hold open, streamline cover, SNB (PA only)
5301 BC EDA	Closer, BF-6, extra duty arm, streamline cover, SNB (PA only)
5301 BC EDAHO	Closer, BF-6, extra duty hold open, streamline cover, SNB (PA only)
5301 BC SCS	Closer, BF-6, door saver w/spring cushion stop, streamline cover, SNB (PA only)
5301 BC SCSHO	Closer, BF-6, door saver hold open w/spring cushion stop, streamline cover, SNB (PA only)
5301 BC TA	Closer, BF-6, track arm, streamline cover, SNB (for body only)
5301 BC TAHO	Closer, BF-6, track arm hold open, streamline cover, SNB (for body only)
5301 BC PS	Closer, BF-6, pivot stop, streamline cover, SNB (PA only)

5500 Series

CODE	DESCRIPTION
5501 BC PA	Closer, BF-6, full cover, SNB (Tri-pack)
5501 BC RA	Closer, BF-6, regular arm, streamline cover, SNB
5501 BC PA HO	Closer, BF-6, hold open, full cover, SNB (Tri-pack)
5501 BC DS	Closer, BF-6, door saver, full cover, SNB (PA only)
5501 BC DSHO	Closer, BF-6, door saver hold open, full cover, SNB (PA only)
5501 BC EDA	Closer, BF-6, extra duty arm, full cover, SNB (PA only)
5501 BC EDAHO	Closer, BF-6, extra duty arm hold open, full cover, SNB (PA only)
5501 BC SCS	Closer, BF-6, door saver w/spring cushion stop, full cover, SNB (PA only)
5501 BC SCSHO	Closer, BF-6, door saver hold open w/spring cushion stop, full cover, SNB (PA only)
5501 BC TA	Closer, BF-6, track arm, streamline cover, SNB (for body only)
5501 BC TAHO	Closer, BF-6, rack arm hold open, streamline cover, SNB (for body only)
5501 BC PS	Closer, BF-6, pivot stop, full cover, SNB (PA only)

Finishes

					
605 (US3) Bright Brass	625 (US26) Bright Chromium	689 (US28) Aluminum	693 Black	695 Dark Duranodic Bronze	696 (US4) Satin Brass (Gold)

Options

CODE	DESCRIPTION
SCS-1	For 3'0" X 8'0" wood or hollow metal doors and frames
SCS-2	For 4'0" X 8'0" wood or hollow metal doors and frames

5300/5500 SERIES Grade 1 Commercial Closer

Arms

CODE	DESCRIPTION
RA	REGULAR ARM - Can be mounted REG/TJ/PA (requires PA bracket)
EDA	EXTRA DUTY ARM - PA application only (bumper eliminated)
DS	DOOR SAVER ARM (Limiting Stop) - PA application only
DSHO	DOOR SAVER HOLD OPEN ARM (limiting stop) PA application only
EDAHO	EXTRA DUTY ARM HOLD OPEN - PA application only (bumper eliminated)
HO	HOLD OPEN ARM - can be mounted REG/TJ/PA (requires PA bracket)
TA	TRACK ARM ASSEMBLY - (Includes track, arm and screws)
TAHO	TRACK ARM HOLD OPEN
PA	PARALLEL ARM BRACKET - NON HOLD OPEN applications
PAHO	PARALLEL ARM BRACKET- HOLD OPEN applications
PS	PIVOT STOP ARM - Regular and Top Jamb Only

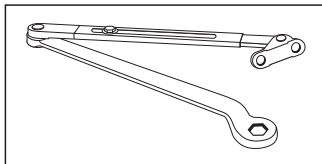

RA - REGULAR ARM

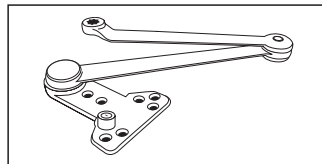

DS - DOOR SAVER (LIMITING STOP) ARM

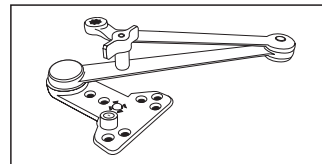

DSHO - DOOR SAVER (LIMITING STOP) HOLD OPEN ARM

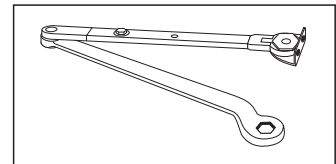

HO - HOLD OPEN ARM

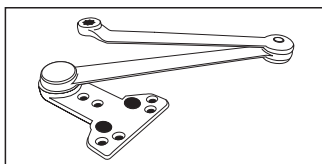

EDA - EXTRA DUTY ARM

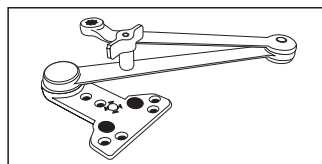

EDAHO - EXTRA DUTY ARM HOLD OPEN

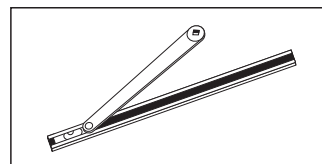

TA - TRACK ARM ASSEMBLY

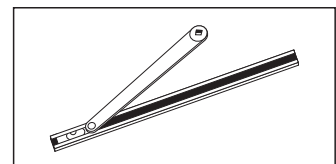

TAHO - TRACK ARM HOLD OPEN

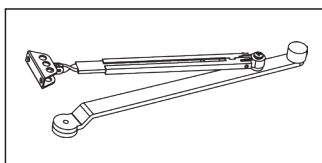

PS - PIVOT STOP ARM

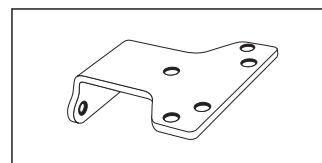

PA - PARALLEL ARM BRACKET

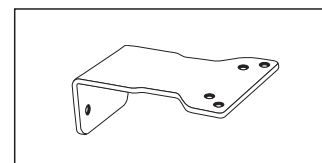

PAHO - PARALLEL ARM HO BRACKET

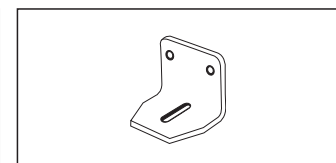

NFB - NARROW FRAME BRACKET