

PDQ Door Hardware

Care & Maintenance Guide

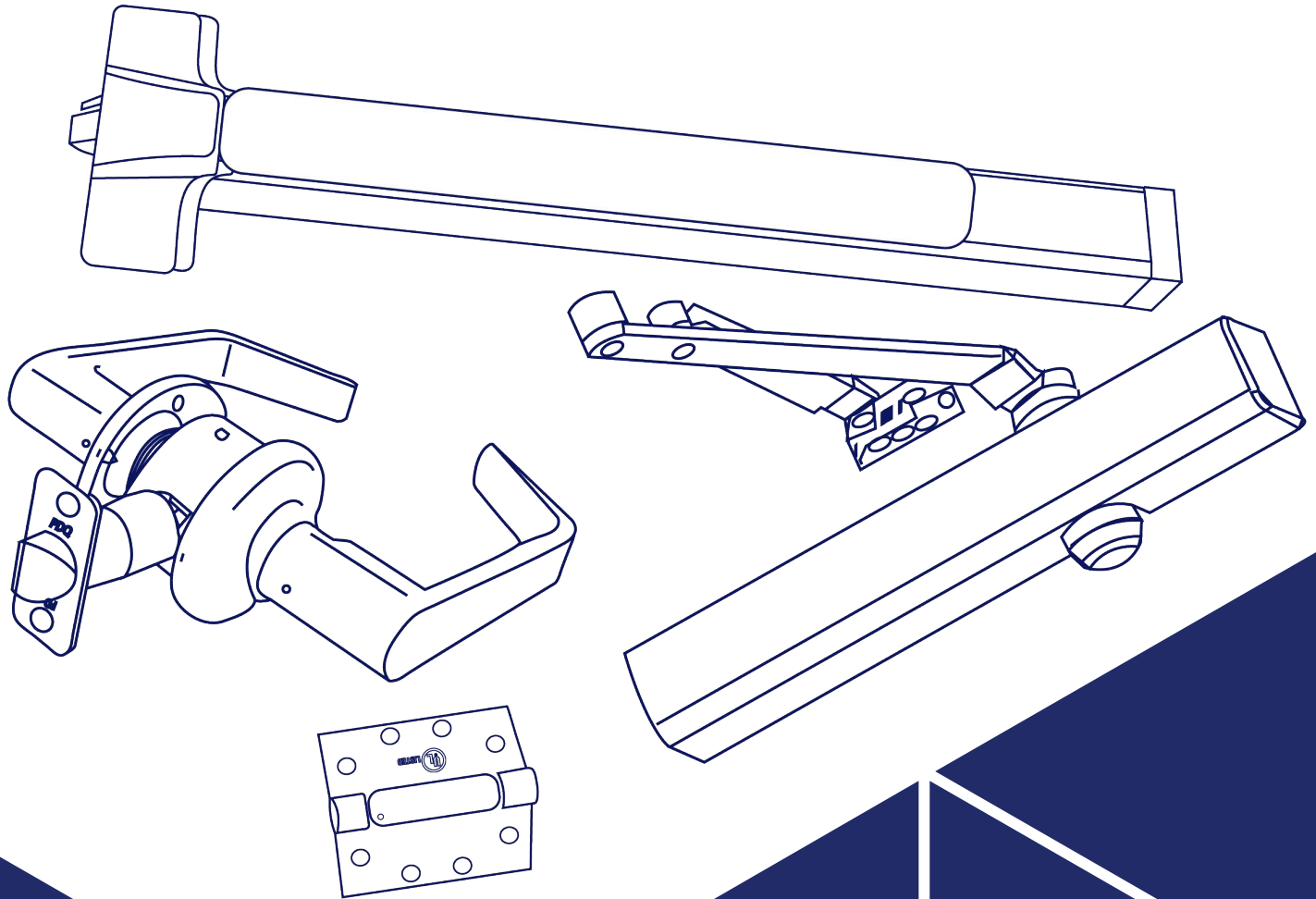

PDQ Manufacturing
2230 Embassy Dr
Lancaster, PA 17603
e: help@pdqlocks.com
p: 800.441.9692

pdqlocks.com











FINISHES

PDQ Manufacturing finishes are durable, top-quality finishes obtained by the processing of solid brass, bronze, stainless steel, and other materials. It is important that usage, climate, and other conditions be taken into consideration when selecting finishes. This is especially true in areas subjected to corrosive vapors, humid climate, or sea air, which in short time may have a damaging effect on finishes. To preserve appearance, cleaning and care may be required. Non-clear coated finishes should not be cleaned with soap or solvents; organically coated surfaces should be cleaned periodically with mild, non-abrasive soap and buffed lightly with a clean cloth. Abrasive cleaners or lacquer thinner should not be used to clean the surface of any PDQ product.

BHMA symbols and U.S. Code Designations (noted below in parentheses) are used in some cases to indicate the similarity of finish appearance, regardless of the base material.

Refer to Each Lock Series for Standard Finish Availability.

Architectural

				
605 (US3) Bright Brass	606 (US4) Satin Brass	612 (US10) Satin Bronze	613 (US10B) Oil Rubbed Bronze	619 (US15) Satin Nickel
				
622 (US19) Flat Black	625 (US26) Bright Chromium	626 (US26D) Satin Chromium	629 (US32) Bright Stainless Steel	630 (US32D) Satin Stainless Steel
				
652 (US26D) Satin Chromium				

Painted

			
689 (US28) Aluminum	693 Black	695 Dark Duranodic Bronze	696 (US4) Satin Brass (Gold)

Finishes shown are representative only. Not all products are available in all finishes listed.

LOCKSETS

PDQ lock assemblies are designed for durability and seldom need servicing. During assembly, the points of contact which require lubrication for ease of operation are given an application of high-quality lithium grease. Periodically inspect latch, strike and spring cage screws for tightness. No further servicing should be required for an extended period except where locks are subjected to extremely heavy traffic.

EXIT DEVICES

The following guidelines are recommended to the building owner to ensure proper device operation:

- Check device operation for smooth operation periodically.
- All screws should be checked and tightened as needed.
- All strikes should be checked for proper alignment and adjusted as required.
- Clean parts with soap and water and then lubricate with lithium grease or silicone lubricants. Do not use petroleum-based lubricants.

Yearly adjustment to exit devices should be done to ensure proper function of device.

CLOSERS

Closers that are installed per PDQ's installation instructions and templates should operate properly, however, as seasons change, they may require further adjustment to allow for stack pressure created by HVAC units when going from heat to air conditioning. Also, areas with heavy wind conditions may require further adjustments to overcome the wind for exterior doors to close and latch properly. Periodically lubricate the pivot point on the closer arms with a small amount of silicone-based lubricant to ensure smooth operation and long life. Screws at mounting bracket, closer arm and closer body should be checked and tightened every 12 months or recommended more often for heavy use doors.

ARCHITECTURAL & RESIDENTIAL HINGES

- Hinges must be free swinging without any binding. The use of shims to align hinges, if needed, is acceptable. Metal shims are required at labeled openings.
- Hinges should be checked on a regular basis for lubrication. We recommend that hinges used in commercial, high-frequency applications or those in extreme environmental conditions be lubricated annually to ensure quiet operation and long life.
- Hinges are best lubricated by removing the pin, applying a generous coating of lithium grease, and reinserting the pin by driving it completely down to the shoulder of the pin head.
- If hinges are sized properly for the door and the frequency of use, they will last for a considerable period of time.
- To remove dirt, simply wipe with a soft damp cloth.
- If hinges begin to make any noise, remove binding conditions, and grease or lubricate all moving parts.

TRIM & AUXILIARY

- Abrasive cleaners or lacquer thinner should not be used to clean the surface of this product.
- Periodically lubricate any moving parts with a silicone based or lithium grease.
- Inspect screws for tightness.